

GENERAL SUSPENSION FORK MANUAL

! WARNING !

Carefully read, understand and follow the instructions provided in this manual, and keep it in a safe place for future reference. If you have any doubt whatsoever regarding the use or maintenance of any SR SUNTOUR product, please contact SR SUNTOUR. Failure to follow these warnings and instructions can result in product malfunction, causing an accident, severe injury or death.

Overview.....	2
Important safety information.....	2
Before every ride.....	3
Fork assembly.....	3
Tire clearance test.....	4
Tire clearance.....	4
Suggested tire size.....	5-6
Maximum brake rotor size.....	7
15AH2/12AH2 bolted thru axle assembly.....	8
20mm bolted thru axle assembly.....	9
20mm cross thru axle assembly.....	9
Q-LOC assembly.....	10
Setting SAG.....	11
Air pressure adjust.....	12
Air volume adjust.....	13
Coil spring preload.....	14
Maintenance of the fork.....	14
Intended use.....	15



We have language options for CN, DE, EN, ES, FR, IT, JP & NL on our website. Please navigate to:

www.srsuntour-cycling.com > Service > Download area > Consumer Downloads > Bike > Owners manuals > General Fork Manual

OVERVIEW

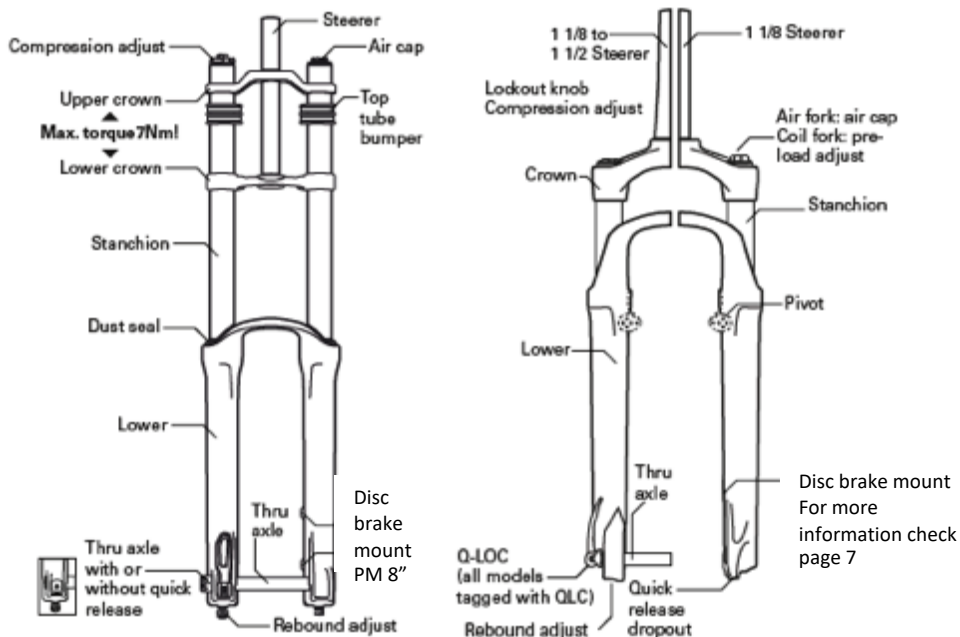

IMPORTANT SAFETY INFORMATION

WARNING !

Failure to follow all warnings and safety instructions can cause your product to malfunction, resulting in an accident, severe personal injuries or even death to the rider.

- Read this manual thoroughly before using your suspension system.
- These instructions contain important information about the correct installation, service and maintenance of your suspension fork. Common mechanical knowledge may not be sufficient. Your suspension fork should only be installed, serviced and/or maintained by a trained and qualified bicycle mechanic with specialized tools.
- Our suspension systems contain fluids and gases under extreme pressure. Never try to open any SR SUNTOUR suspension system! Pieces can be violently ejected.
- SR SUNTOUR suspension forks are designed as a single integrated system. To avoid product malfunction and an accident, use only genuine SR SUNTOUR spare parts. The use of third-party supplier spare parts also voids the warranty of your suspension system.
- Your suspension fork is not intended for jumps, aggressive downhill rides, freeride or dirt jumping if the warning sticker on your suspension system prohibits these activities. Disregarding these instructions may cause your suspension fork to fail, resulting in an accident, personal injury or death, and will void the warranty.
- SR SUNTOUR suspension fork is designed for use by a single rider.
- Select the correct suspension fork according to your frame's dimensions and your personal riding style. Installing a suspension fork which does not match the geometry of your frame could result into a failure of the suspension fork or frame itself, and will void the shocks warranty.
- failure of the suspension fork or frame itself, and will void the shocks warranty.
- Know the limits of your skill and experience, and never ride beyond them.
- Read, understand and follow all owner's manuals provided with your bike and all of its components.
- Always be equipped with proper safety gear. This includes a properly fitted and fastened helmet. According to your riding style you should use additional safety protection. Make sure your equipment is in flawless condition.
- Even if you had a suspension system in the past, ride carefully and slowly to become accustomed to the feel of your new suspension fork.
- SR SUNTOUR suspension forks are not equipped with front reflectors for use on public roads. If you intend to use your bicycle on public roads or bicycle paths, you must install the required front reflectors. Please contact your dealer.
- If you are using a bicycle rack that requires the front wheel to be removed, carefully insert and remove the dropouts from the bike rack. Do not bend the dropouts !
- If you are using a bicycle rack that fastens the bicycle at the front dropouts only, then the rear wheel must be securely fastened to prevent movement of the rear wheel. Movement of the rear wheel will damage the front dropouts, and this damage may not be visible to you.
- If the bicycle has fallen off the bicycle rack, have it inspected by a qualified bicycle mechanic before riding it again.

BEFORE EVERY RIDE

WARNING !

Avoid serious personal injury or even death. Do not ride the bicycle if any of the following criteria is not met! Correct any condition before you ride.

- Inspect your bicycle and suspension system including the handlebars, pedals, crank arms, seat post, saddle, etc. for any cracks, dents, bent or tarnished parts. Also search for any oil leaking out of your shocks. Be sure to check hidden areas on the underside of your bike. If any condition exists, consult a trained and qualified bicycle mechanic to determine the cause and make any necessary correction.
- Compress your suspension system with your body weight. If it feels too soft, make the necessary adjustments until you have reached the correct SAG value. Please also see the instruction in this manual regarding SAG.
- Make sure your brakes are properly installed/adjusted and work correctly.
- Spin the wheels. Make sure that wheels are perfectly centered and do not contact the suspension fork or brakes.
- If you are using a quick release system to fasten your wheel set, make sure that all levers and nuts are properly tightened. In case you are using a through axle system, make sure that all fixing bolts are tightened with the appropriate torque values. Strictly follow the instructions provided by the manufacturer of the quick release or through axle system.
- Check the cable length and routing of your components. Make sure they do not interfere with your steering of the bicycle.
- If you are using reflectors for on-road cycling, make sure they are clean and properly installed.
- Check mounting hardware of all components to make sure everything is tightened.
- Bounce your bike on the ground while looking and listening for anything which might be loose.

FORK ASSEMBLY

WARNING !

Avoid product malfunction, an accident, personal injury or death. Your new SR SUNTOUR suspension fork should be installed, maintained and serviced by a qualified and trained bicycle mechanic. Avoid product failure and an accident, personal injury or death. All mounting screws must be tightened with the respective torques specified by the manufacturer of each individual component (i.e., brake, headset, etc.).

1. Remove the old fork from your bicycle. Remove the headset crown race from the fork.
2. Measure the length of the steerer tube of your old fork and compare it to the length of the steerer tube of the SR SUNTOUR fork. The standard length of SR SUNTOUR suspension fork steerer tube is 255mm. It may be necessary to shorten the steerer tube to the correct length.
3. Install the fork crown race firmly at the top of your fork crown. Reattach the fork assembly (headset, spacer, handlebar stem) to the bicycle. Adjust the headset until no more play is observed. Further information can be found in the installation instructions of the headset manufacturer.
You can use the following formula to determine the proper length of the steerer tube: Head tube of the frame + Headset height + Spacer if applicable + Height of the stem - 3 mm distance = Length of the steerer tube
4. Install and properly adjust the brakes according to the brake manufacturer's instructions. If you are using a disc brake, install the brake only into the designated threaded receptacle hole for the disc brake. Use only cantilever brakes that are made for use without reinforcing brace. Follow the assembly instructions of your brake manufacturer. Select the proper length for the brake cable so that it does not interfere with the fork or steering.
5. Reattach the front wheel. Make sure that all clamping levers and nuts are set and tightened properly (at least four threads must engage in the adjusting nut when the quick release is locked). If the fork is equipped with a thru-axle system, then all screws must be checked for proper torque. Follow the instructions of the Quick Release or Turn-Axle manufacturer.

TIRE CLEARANCE TEST

1. Depressurize the fork. (if equipped with air suspension)
2. Compress the fork all the way.
3. Measure the distance between the top of your tire and the underside of the fork crown. The distance must not be less than 10 mm! If the tire is too big, it will touch the underside of the crown when the fork is fully compressed.
4. Relieve the fork and pump it up again if it is an air fork.
5. Take into account that the gap is reduced if you are using a fender! Repeat the “tire clearance test” to ensure that the distance is sufficient. You must repeat this test every time you change your tires to another size!

TIRE CLEARANCE

 **WARNING !**

Using a tire that is larger than the maximum tire size allowed for your fork is very dangerous and can cause accidents, serious injuries and even death. Inadequate tire clearance will result in sudden and unexpected loss of bicycle control, an accident, personal injury or death.

Below dimensions are based on the bottom case type. Some numbers are referred based on the bottom case type which have fender mount interface, and some are without. Please check in advance whether the wheel and fork are compatible. The necessary information can be found on the side of the tire. Every tire has a different external diameter (width and height of the tire). For this reason, check the distance between your tire and the fork to make sure your tire does not touch the fork under any circumstances. Bear in mind that the narrowest part of the fork is at the brake boss level. If you want to remove your wheel, you must release the air from your tire, among other things, in order to fit it through the brake boss level.

SUGGESTED TIRE SIZE

Fork model	Stanchion size	Suggested tire size	Max tire width	Max. tire outer diameter (O.D.) (* Note below)
RUX38 29" BT	38mm	29" x 2.8"	73mm	770mm
RUX38 27.5" BT	38mm	27.5" x 2.8"	73mm	732mm
DUROLUX38 29" BT	38mm	29" x 2.6" / 27.5" x 2.8"	63mm	756mm
DUROLUX36 29" BT	36mm	29" x 2.6" / 27.5" x 2.8"	63mm	756mm
DUROLUX36 27.5" BT	36mm	27.5" x 2.6"	63mm	723mm
AURON35 29" BT	35mm	29" x 2.4" / 27.5" x 2.8"	63mm	756mm
AURON35 27.5" BT	35mm	27.5" x 2.8"	73mm	737mm
AURON34 29"	34mm	29" x 2.25"	58mm	752mm
AURON34 27.5"	34mm	27.5" x 2.25"	58mm	708mm
AION35 29" BT	35mm	29" x 2.4" / 27.5" x 2.8"	63mm	756mm
AION35 27.5" BT	35mm	27.5" x 2.8"	73mm	737mm
AION34 29"	34mm	29" x 2.25"	58mm	752mm
AION34 27.5"	34mm	27.5" x 2.25"	58mm	708mm
ZERON35 29" BT	35mm	29" x 2.4" / 27.5" x 2.8"	63mm	756mm
ZERON35 27.5" BT	35mm	27.5" x 2.8"	73mm	737mm
AXON34-werx 29" BT	34mm	29" x 2.4"	63mm	756mm
AXON34-elite 29" BT	34mm	29" x 2.4"	63mm	756mm
AXON34 29" BT	34mm	29" x 2.4"	63mm	760mm
AXON34 27.5" BT	34mm	27.5" x 2.6"	67mm	725mm
AXON32 29" BT	32mm	29" x 2.4"	63mm	756mm
AXON32 27.5" BT	32mm	27.5" x 2.5"	66mm	724mm
AXON32 29"	32mm	29" x 2.25"	58mm	754mm
AXON32 27.5"	32mm	27.5" x 2.25"	58mm	710mm
EPIXON 29"	32mm	29" x 2.25"	58mm	754mm
EPIXON 27.5"	32mm	27.5" x 2.25"	58mm	710mm
EPIXON 26"	32mm	26" x 2.25"	58mm	684mm
RAIDON34 29" BT	34mm	29" x 2.4"	63mm	760mm
RAIDON34 27.5" BT	34mm	27.5" x 2.6"	67mm	725mm
RAIDON32 29" BT	32mm	29" x 2.4"	63mm	756mm
RAIDON32 27.5" BT	32mm	27.5" x 2.5"	66mm	724mm
RAIDON32 29"	32mm	29" x 2.25"	58mm	754mm
RAIDON32 27.5"	32mm	27.5" x 2.25"	58mm	710mm
RAIDON32 26"	32mm	26" x 2.25"	58mm	684mm
XCR34 29" BT	34mm	29" x 2.4"	63mm	760mm
XCR34 27.5" BT	34mm	27.5" x 2.6"	67mm	725mm
XCR32 29" BT	32mm	29" x 2.4"	63mm	756mm
XCR32 27.5" BT	32mm	27.5" x 2.5"	66mm	724mm
XCR32 29"	32mm	29" x 2.25"	58mm	754mm
XCR32 27.5"	32mm	27.5" x 2.25"	58mm	710mm
XCR32 26"	32mm	26" x 2.25"	58mm	684mm
XCR 24"	32mm	24" x 2.1"	54mm	624mm

XCM34 29 BT	34mm	29" x 2.4"	63mm	756mm
XCM34 27.5 BT	34mm	27.5" x 3.0"	78mm	740mm
XCM32 29" BT	32mm	29" x 2.4"	63mm	752mm
XCM32 27.5" BT	32mm	27.5" x 2.6"	67mm	730mm
XCM 24" BT	30mm	24" x 2.8"	73mm	678mm
XCM 29"	30mm	29" x 2.4"	63mm	758mm
XCM 27.5"	30mm	27.5" x 2.25"	58mm	714mm
XCM 26"	30mm	26" x 2.25"	58mm	688mm
XCM-JR. 20"	28mm	20" x 2.1"	56mm	526mm
XCT30 29"	30mm	29" x 2.25"	58mm	750mm
XCT30 27.5"	30mm	27.5" x 2.25"	58mm	714mm
XCT L24"	28mm	24" x 2.1"	54mm	628mm
XCT 20" plus	28mm	20" x 2.8"	73mm	554mm
XCT L20"	28mm	20" x 2.1"	56mm	526mm
XCT 24"	25.4mm	24" x 2.1"	54mm	628mm
XCT 20"	25.4mm	20" x 2.1"	56mm	526mm
XCE28 29"	28mm	29" x 2.25"	58mm	750mm
XCE28 27.5"	28mm	27.5" x 2.25"	58mm	714mm
XCE28 26"	28mm	26" x 2.1"	54mm	680mm
MOBIE34 700C	34mm	700C x 57C	62mm	753mm
MOBIE34 27.5"	34mm	27.5" x 2.4"	63mm	717mm
MOBIE45 700C	34mm	700C x 57C	59mm	751mm
MOBIE45 27.5"	34mm	27.5" x 2.4"	63mm	717mm
MOBIE25 700C	32mm	700C x 57C	59mm	751mm
MOBIE25 27.5"	32mm	27.5" x 2.4"	63mm	717mm
MOBIE-A32 29"	32mm	29" x 2.4"	63mm	760mm
MOBIE-A32 27.5"	32mm	27.5" x 2.4"	63mm	717mm
MOBIE-A32 20" CRG	32mm	20" x 2.25"	58mm	530mm
XCT-ATB 29"	28mm	29" x 2.4"	63mm	760mm
XCT-ATB 27.5"	28mm	27.5" x 2.4"	63mm	724mm
GVX32-15 700C	32mm	700C x 45C	50mm	722mm
NRX32-15 700C	32mm	700C x 48C	50mm	722mm
NRX30 700C	30mm	700C x 48C	50mm	722mm
NVX30 29"	30mm	29" x 2.4"	63mm	760mm
NVX30 27.5"	30mm	27.5" x 2.4"	63mm	717mm
NCX30 700C	30mm	700C x 48C	50mm	722mm
TR-HSi 700C	30mm	700C x 52C	54mm	738mm
NEX-E25 700C	30mm	700C x 52C	54mm	738mm
NEX-E25 26"	30mm	26" x 2.1"	54mm	678mm
NEX 700C	28mm	700C x 48C	50mm	738mm
NEX 26"	28mm	26" x 2.1"	54mm	678mm
M3010-700C	25.4mm	700C x 52C	54mm	742mm
M3010-26"	25.4mm	26" x 2.1"	54mm	684mm
M3010-24"	25.4mm	24" x 2.1"	54mm	630mm
M3010-20"	25.4mm	20" x 2.1"	56mm	526mm
CR85-E25 700C	30mm	700C x 48C	50mm	722mm
CR85-E25 26"	30mm	26" x 2.1"	54mm	684mm
CR8 700C	28mm	700C x 48C	50mm	722mm
CR8 26"	28mm	26" x 2.1"	54mm	684mm
CR7 700C	25.4mm	700C x 48C	50mm	722mm
CR7 26"	25.4mm	26" x 2.1"	54mm	684mm

* Note: Some of above dimensions are referred based on "with fender", and some are without. Please check the specification sheet for more details.

MAXIMUM BRAKE ROTOR SIZE

Fork model	Stanchion size	Rotor size when disc caliper mounted directly	Max. rotor size
RUX38 29" BT	38mm	203mm	203mm
RUX38 27.5" BT	38mm	203mm	203mm
DUROLUX38 29" BT	38mm	203mm	220mm
DUROLUX36 29 BT	36mm	180mm	220mm
AURON35 29"/27.5" BT	35mm	180mm	203mm
AURON34 29"/27.5"	34mm	160mm	203mm
AION35 29"/27.5" BT	35mm	180mm	203mm
AION34 29"/27.5"	34mm	160mm	203mm
ZERON35 29"/27.5" BT	35mm	180mm	203mm
AXON34-werx 29" BT	34mm	160mm	180mm
AXON34 29"/27.5" BT	34mm	180mm	203mm
AXON32 29"/27.5" BT	32mm	160mm	180mm
AXON32 29"/27.5"	32mm	160mm	180mm
EPIXON 29"/27.5"/26"	32mm	160mm	180mm
RAIDON34 29"/27.5" BT	34mm	180mm	203mm
RAIDON32 29"/27.5" BT	32mm	160mm	180mm
RAIDON32 29"/27.5"/26"	32mm	160mm	180mm
XCR34 29"/27.5" BT	34mm	180mm	203mm
XCR32 29"/27.5" BT	32mm	160mm	180mm
XCR32 29"/27.5"/26"	32mm	160mm	180mm
XCR 24"	32mm	160mm	180mm
XCM34 29"/27.5" BT	34mm	160mm	203mm
XCM32 29"/27.5" BT	32mm	160mm	180mm
XCM30 29"/27.5"/26"	30mm	160mm	180mm
XCM 24" BT	30mm	160mm	180mm
XCM-JR. 20"	30mm	160mm	180mm
XCT30 29"/27.5"	30mm	160mm	180mm
XCT28 L24"	28mm	160mm	180mm
XCT 20" plus	30mm	160mm	180mm
XCT L20"	30mm	160mm	180mm
XCT 24"/20"	25.4mm	160mm	180mm
XCE28 29"/27.5"/26"	28mm	160mm	180mm
Mobie45 700C/27.5"	34mm	160mm	203mm
MOBIE34 700C/27.5"	34mm	180mm	203mm
Mobie25 700C/27.5"	32mm	160mm	180mm
Mobie-A32 29"/27.5"	32mm	160mm	180mm
MOBIE-A32 20" CRG	32mm	160mm	180mm
XCT-ATB 29"/27.5"	28mm	160mm	180mm
GVX32-15 700C	32mm	160mm	180mm
NRX32-15 700C	32mm	160mm	180mm
NRX30 700C	30mm	160mm	180mm
NVX30 29"/27.5"	30mm	160mm	180mm
NCX30 700C	30mm	160mm	180mm
NCX28 26"	28mm	160mm	180mm
NEX-E25 700C	30mm	160mm	180mm
NEX 700C/26"	28mm	160mm	180mm
M-series	25.4mm	160mm	180mm

15AH2/12AH2 BOLTED THRU AXLE ASSEMBLY

Note: Before installation, make sure to check the o-ring is correctly seated at the thread part.

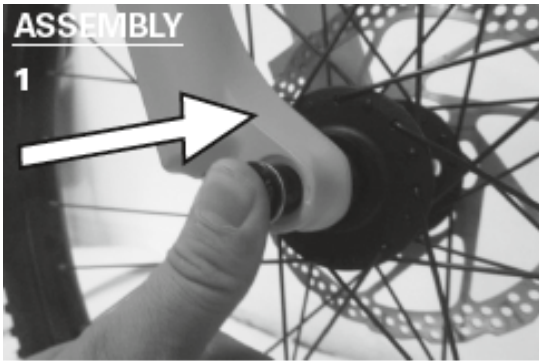

1. Fully insert the axle on the drive-side.



2. Tighten the axle with a 6mm Allen wrench by the suggested tightening torque of 8-10Nm.



3. Check the axle's thread. It must be visible.

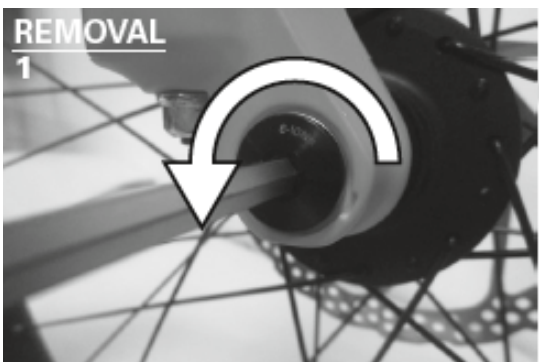

1. Loosen the axle on the drive side with a 6mm.

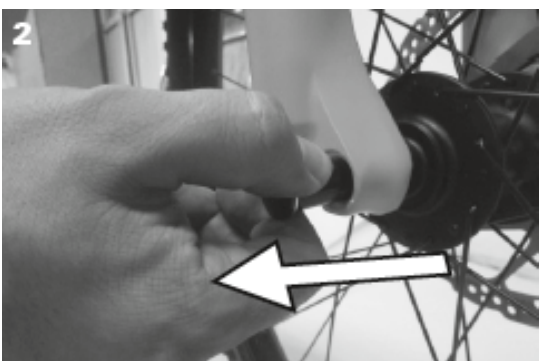

2. Pull out the axle.

20MM BOLTED THRU AXLE ASSEMBLY



1. Slide in the axle and tighten it with a 6mm Allen wrench by suggested tightening torque of 10Nm.



2. Tighten the safety clamp with a 4mm Allen wrench by suggested tightening torque of 7Nm.

20MM CROSS THRU AXLE ASSEMBLY

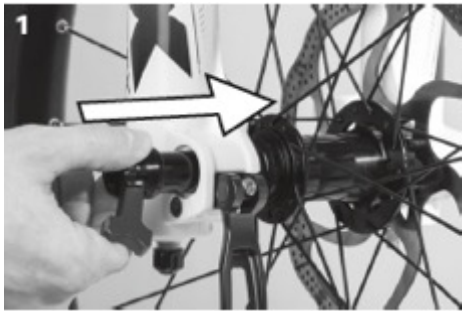

1. Slide in the axle on the quick-lock side.

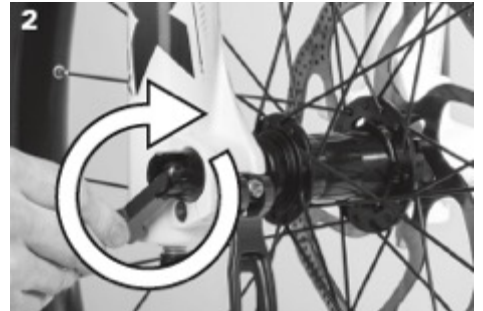

2. Tighten the axle with the red lever.



3. It is possible to slide the lever into the axle now.

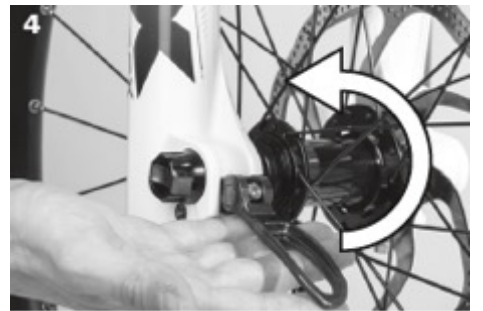

4. Lock the quick release.



5. Set the tensioning force with a 4 mm Allen wrench if needed.



6. The lever should be flush to the bottom case.

Q-LOC ASSEMBLY

ASSEMBLY

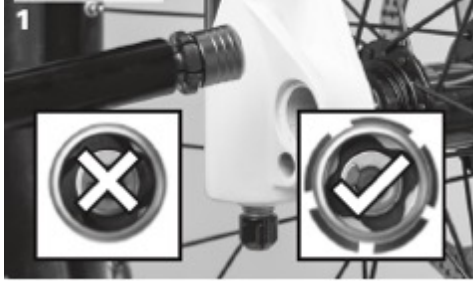

1. Check the segmented flange to be expanded before installation and open the lever completely.

2. Slide in the axle until it "clicks". **Make sure the segmented flange is expanded.**

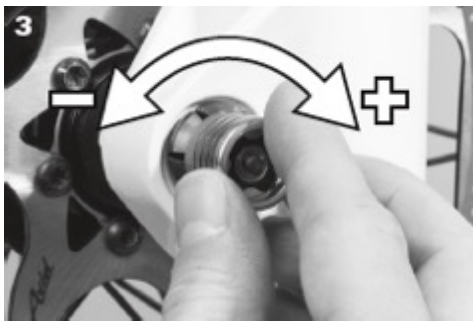
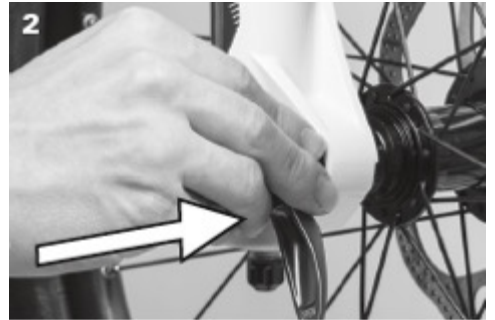

3. Set the tension of the nut until the flange is flush with the dropout.

4. Close the lever completely. Check if it's firmly seated. Re-tighten the nut if necessary.



REMOVAL



1. Open the lever completely.

2. Press adjust nut until segmented flange retracts.

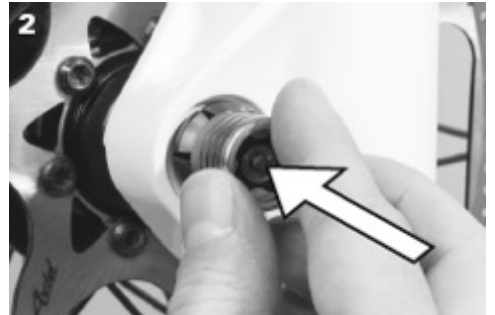

3. Open the lever completely. Turn nut clockwise until flange stays latched.

4. Pull out the axle.



SETTING “SAG”

To achieve the best performance from your SR SUNTOUR suspension air spring forks, adjust the air pressure to attain your proper sag setting. Sag is the amount your suspension compresses under your weight and riding gear and luggage. Sag range should be set of total fork travel. Make sure to set sag with the compression knob in the OPEN position.

- Below chart is the suggested SAG range and the original air pressure chart, set for the SR SUNTOUR air suspension forks from the factory. Remember that these are the starting points. Adjustments will vary based on rider ability, trail conditions, frame design, and personal preference. After setting up your suspension fork, check your sag to make sure that you are within the recommended SAG settings.
- The SAG is the compression which is caused by the rider’s weight including equipment (such as backpack), seating position and the frame’s geometry and not as a result of riding. Every rider has a different weight and seating position. Therefore the front fork will sag more or less. To assure a proper function of suspension front fork and not to interfere its performance, setting a proper SAG is the important way to find the correct air pressure for your air suspension fork.

Setting tip for EQ air forks

- Step 1: Put the suggested air pressure and compress the fork at least 50% of full travel several times in order to equalize the air pressure between positive and negative air chamber.
 - Step 2: Sit on the bike with equipment (such as backpack) and ask somebody holding the bike, stand on the pedals, and the compress the fork several times. Then sit on your bike at your normal riding position.
 - Step 3: Slide the SAG indicator O-ring down to the top of the dust seal.
 - Step 4: Gently step off the bike without compressing the fork furthermore.
 - Step 5: Check the O-ring position to see if the SAG setting is properly done.
 - Step 6: In case if the SAG setting is not properly done, air pressure must be adjusted.
 - In order to increase the SAG, decrease the air pressure.
 - In order to decrease the SAG, increase the air pressure.
- ✓ Repeat the above procedure until you can find the correct SAG setting.

Fork travel	SAG (%)	SAG (mm)
200 - 180mm	30 - 35%	70 - 54mm
180 - 160mm	25 - 30%	54 - 40mm
160 - 140mm	20 - 25%	40 - 28mm
140 - 120mm	20 - 25%	35 - 24mm
120 - 100mm	15 - 20%	24 - 15mm
100 - 80mm	15 - 20%	20 - 12mm
80 - 63mm	10 - 15%	12 - 6mm

AIR PRESSURE ADJUST



WARNING !

The suggested settings in this manual are designed to be a starting point, in order to get you on your first ride in as simple as possible. For more details, consult a qualified and trained bicycle mechanic at your bike shop to get proper advice.

As you ride and getting used to your fork, adjust the settings as needed.

Rider weight (kg)	Suggested air pressure (psi) <EQ air system forks>		
	RUX38 / DUROLUX38	DUROLUX36 / AURON35	AXON34-werx
< 55	< 40	35 - 50	40 - 55
55 - 65	40 - 50	50 - 60	55 - 65
65 - 75	50 - 60	60 - 70	65 - 75
75 - 85	60 - 70	70 - 85	75 - 85
85 - 95	70 - 85	85 - 105	85 - 100
95 <	85 +	105 +	100 +
Air pressure (factory setting)	70psi	90psi	95psi
Max. pressure	105psi	120psi	145psi

Rider weight (kg)	Suggested air pressure (psi) <Air system forks>									
	AION35 ZERON35	AXON34 RAIDON34 XCR34-air	AXON32 EPIXON32 RAIDON32 XCR32-air	XCR 24" air	XCM-Jr.- air	MOBIE34- air MOBIE45- air	Mobie25- air	GVX32-air	NRX-air	NCX-air
< 55	35 - 50	40 - 55	40 - 55	40 - 55	40 - 55	35 - 50	40 - 55	40 - 55	40 - 55	40 - 55
55 - 65	50 - 60	55 - 65	55 - 65			50 - 60	55 - 65	55 - 65	55 - 65	55 - 65
65 - 75	60 - 70	65 - 75	65 - 75			60 - 70	65 - 75	65 - 75	65 - 75	65 - 75
75 - 85	70 - 85	75 - 85	75 - 85			70 - 85	75 - 85	75 - 85	75 - 85	75 - 85
85 - 95	85 - 105	85 - 100	85 - 100			85 - 105	85 - 100	85 - 100	85 - 100	85 - 100
95 <	105 +	100 +	100 +			105 +	100 +	100 +	100 +	100 +
Air pressure (factory setting)	90psi	95psi	110psi	50psi	50psi	90psi	100psi	85psi	85psi	80psi
Max. pressure	120psi	145psi	145psi	100psi	100psi	120psi	130psi	120psi	120psi	120psi

Note:

Above numbers are reference only. Correct air pressure must be adjusted by individual rider while checking the sag.

AIR VOLUME ADJUST

Additional tuning options: Air Volume Adjust Spacers

Changing air volume spacers in some fork models is an easy internal adjustment that allows you to change the amount of mid stroke and bottom out resistance.

Even if you have set your sag, but using full travel (bottoming out) too easily, then you could install one or more spacers to increase bottom out resistance.

Even if you have set your sag, but still not using full travel, then you could remove one or more spacers to decrease bottom out resistance.

Installation procedure and tuning options can be suggested as below chart.

		EQ air system forks									
		Number of Air volume spacers (rubber clip type)									
		RUX38		DUROLUX38		DUROLUX36		AURON35		AXON34-werx	
Resin spacer volume		8.6cc		8.2cc		7.5cc					
Rubber spacer volume				7.5cc-15mm		7.5cc-15mm		7.5cc-15mm		5cc-10mm	
		Factory setting	Max. possible spacers	Factory setting	Max. possible spacers	Factory setting	Max. possible spacers	Factory setting	Max. possible spacers	Factory setting	Max. possible spacers
Resin spacer		5	5	3	3	3	3				
Rubber spacer Travel	200mm										
	180mm			2	6	1	6				
	170mm			3	6	2	6				
	160mm			4	6	3	6	7	10		
	150mm					4	6	8	10		
	140mm							9	10		
	130mm										
	120mm									3	8
	110mm									3	8
100mm									3	8	

		Air system forks									
		Number of Air volume spacers (rubber clip type)									
		AION35		ZERON35		AXON32		MOBIE34-air		MOBIE45-air	
Rubber spacer volume		5cc		5cc		4.3cc		5cc		5cc	
Travel		Factory setting	Max. possible spacers	Factory setting	Max. possible spacers	Factory setting	Max. possible spacers	Factory setting	Max. possible spacers	Factory setting	Max. possible spacers
160mm		3	6								
150mm		3	6	3	6						
140mm		3	6	3	6						
130mm		3	6	3	6						
120mm		3	6			2	4				
100mm						2	4	2	5	2	5
80mm								2	5	2	5
60mm										2	5

Note:

Don't exceed the Maximum Volume spacers number because this can damage your fork.

COIL SPRING PRELOAD

The fork can be adjusted to the rider's weight and preferred riding style via the spring preload. It is not the coil spring hardness that is set, but the spring preload. This reduces the "SAG" of the fork when the rider sits down. A medium hardness spring is used as standard setting. Turn the preload adjust knob clockwise to increase the spring preload and turn it counter-clockwise to reduce it. Two additional spring hardnesses are available for SR SUNTOUR suspension forks - softer and harder than the standard coil spring.



MAINTENANCE OF THE FORK

As long as moving parts are exposed to moisture and contamination, the performance of your suspension system might be reduced after several rides. To maintain high performance, safety and long life of your suspension system, periodic maintenance is required.

- **A suspension system which has not been serviced in accordance with the maintenance instructions will not be covered under warranty.**
- **Never use a pressure washer or any water under pressure to clean your suspension fork as water may enter the fork at the dust seal level. Never use aggressive cleaners. We recommend clear water and a damp cloth to wipe down your fork.**
- **Your suspension fork should be serviced more frequently as indicated below if you ride in extreme weather (winter time, or in wet/muddy conditions) and rough terrain conditions.**
- **If you believe that your suspension system performance has changed or handles differently, immediately contact your local dealer to inspect your fork.**
- **After every ride: Clean the fork stanchion tubes and dust seals and maintain with an oily cloth. Check stanchion tubes for dents, scratches or other discoloration or leaking oil.**
- **Every 50 hours: Maintenance 1 (at dealer)**
- **Every 100 hours or once a year: Maintenance 2 (at dealer, ideally before winter time in order to protect all parts from the effects of weather by proper greasing)**

MAINTENANCE 1:

Check function of fork / check torques of mountings screws and nuts on bottom of lowers (suggested tightening torque: bolt: 10Nm, nut: 8Nm) / check for scratches, dents, cracks, discoloration, signs of wear and signs of minor corrosion (maintain with oily cloth), or oil leaks.

MAINTENANCE 2:

Maintenance 1 + disassembly / cleaning the entire fork inside and out / cleaning and lubricating dust seals and slider sleeves / checking torques / adjusting to the riders liking.

Before disassembly, check the slider sleeve play of the fork. To do so, apply the front wheel brake and gently push the bicycle back and forth at the handlebar stem shaft. Replace the slider sleeves if the play is excessive (more than 1 mm at the fork brace).

INTENDED USE

	Pedal assist E-bike (EU speed pedalec or US-Class 3)	Pedal assist E-bike (EU pedalec or US-Class 1 & 2); on-road	Pedal assist E-bike (EU pedalec or US-Class 1 & 3); off-road	Cross bike	Trekking bike	City bike	Down hill bike	Enduro bike	All mountain bike	Cross country racing bike	Cross country bike
	Warning	Warning	Warning	Warning	Warning	Warning	Warning	Warning	Warning	Warning	Warning
	USE ONLY FOR	USE ONLY FOR	USE ONLY FOR	USE ONLY FOR	USE ONLY FOR	USE ONLY FOR	USE ONLY FOR	USE ONLY FOR	USE ONLY FOR	USE ONLY FOR	USE ONLY FOR
	Pedal assist bikes EU speed pedalec or US-Class 3 for on-road or casual off-road use	Pedal assist bikes EU pedalec or US-Class 1 & 2 for on-road use	Pedal assist bikes EU pedalec or US-Class 1 & 2 for off-road use	Paved road or casual off-road use	Paved road or casual off-road use	Paved road use	Downhill	Cross country, Trail and Enduro use	Cross country, Trail and All mountain use	Cross country racing and cross country use	Cross country use
	DO NOT USE FOR	DO NOT USE FOR	DO NOT USE FOR	DO NOT USE FOR	DO NOT USE FOR	DO NOT USE FOR		DO NOT USE FOR	DO NOT USE FOR	DO NOT USE FOR	DO NOT USE FOR
Downhill, Enduro, All mountain, Cross country racing, Cross country	Downhill, Enduro	Downhill	Downhill, Enduro, All mountain, Cross country racing, Cross country	Downhill, Enduro, All mountain, Cross country racing, Cross country	Downhill, Enduro, All mountain, Cross country racing, Cross country	Downhill, Enduro, All mountain, Cross country racing, Cross country	Downhill	Downhill	Downhill, Enduro, All mountain	Downhill, Enduro, All mountain, Cross country racing	
MOBIE34	0	0									
MOBIE45	0	0									
MOBIE25		0									
MOBIE-A32		0		0							
MOBIE-A32 20" CRG	0	0									
XCT-ATB				0							
GVX32-15		0		0							
NRX32		0		0							
NRX30				0							
NVX30				0							
NCX		0		0	0						
NEX-E25		0		0							
CR85-E25		0		0							
TR-HSI				0	0						
NEX				0	0						
M3010					0						0
M3010 24"/20"						0					0
CR8						0					
CR7						0					
RUX38 BT			0				0				
DUROLUX38 BOOST			0					0			
DUROLUX36 BOOST			0					0			
AURON35 BOOST			0						0		
AURON34									0		
AION35 BOOST			0						0		
AION34									0		
ZERON35 BOOST			0						0		
AXON34 werx BOOST										0	
AXON34 elite BOOST										0	
AXON32 werx										0	
AXON34 BOOST			0								0
AXON32 BOOST											0
AXON32											0
EPIXON											0
RAIDON34 BOOST		0	0								0
RAIDON32 BOOST											0
RAIDON32											0
XCR34 BOOST		0	0								0
XCR32 BOOST											0
XCR32											0
XCR24"											0
XCM34 BOOST		0	0								0
XCM32 BOOST											0
XCM											0
XCM 24" BT					0						0
XCM-JR. 20"					0						0
XCT30					0						0
XCT 24" plus					0						0
XCT28 L24"					0						0
XCT 20" plus					0						0
XCT L20"					0						0
XCT 24"/20"					0						0
XCE28					0						0

CUSTOMER SUPPORT OFFICES

ASIA, OCEANIA

SR SUNTOUR INC.

#7 Hsing Yeh Road
Fu Hsing Industrial Zone
Chang Hua, Taiwan, R.O.C.
Tel: +886-(0)4-769-5115
service@srsuntour.com.tw

SR SUNTOUR INTERNATIONAL CO., LTD.

No. 1500 Honghu Road, Penglang
Kunshan, Development Zone
Jiang Su Province, China ZIP 215333
Tel: +86-512-5517-1127
sr-service@srsuntour.com.cn

SRS INTERNATIONAL TRADING LTD.

Room 501, 5th floor, Building No. 2
Jiaxing Industrial Zone, Shubei Road
Gongming Town, Guangming District
Shenzhen City, China 518106
Tel: +86-755-271-084 83
service@srsuntour.com.cn

SR SUNTOUR JAPAN

NR Bldg. 4F, 3-13-13 Kuramae
Taito-ku, Tokyo, 111-0051
Tel: +81-3-5829-9211

EUROPE

SR SUNTOUR EUROPE GmbH

Riedstrasse 31
83627 Warngau, Germany
Tel: +49-(0)802-150-793-0
service@srsuntour-cycling.com

SR SUNTOUR Technical Service Center

Max-Planck-Str. 4
97526 Sennfeld, Germany
Tel: +49-(0)9721-473-4896
service@srsuntour-cycling.com

SAV SR SUNTOUR FRANCE

604 voie Galilee
73800 Sainte Helene du Lac, France
Tel: +33-(0)981-241650
sav@srsuntour-cycling.com

USA

SR SUNTOUR North America Inc.

7509 S. 5th Street Suite 124
Ridgefield, Washington 98642
Tel: +1-360-737-6450
Sales: ssna@srsuntourna.com
Service, warranty: service@srsuntourna.com

SR SUNTOUR Madison

910 Watson Avenue
Madison, Washington 53713 USA
Tel: +1-608-229-6610
service@usulcorp.com

WEB LINKS

For further information please visit www.srsuntour-cycling.com. There you will also find:

- ◆ Service request: <http://www.srsuntour-cycling.com/service/service-request>
- ◆ Tech videos: <http://www.srsuntour-cycling.com/service/tech-videos>
- ◆ Download area: <http://www.srsuntour-cycling.com/service/download-area>
- ◆ Owners manuals: <http://www.srsuntour-cycling.com/ja/service/download-area/consumer-downloads/bike/owners-manuals/general-fork-manual/>
- ◆ Fork glossary: <http://www.srsuntour-cycling.com/service/fork-glossary>
- ◆ Warranty: <http://www.srsuntour-cycling.com/service/warranty>