

Color by Numbers

BEGINNER

Finding Furry Friends Edition

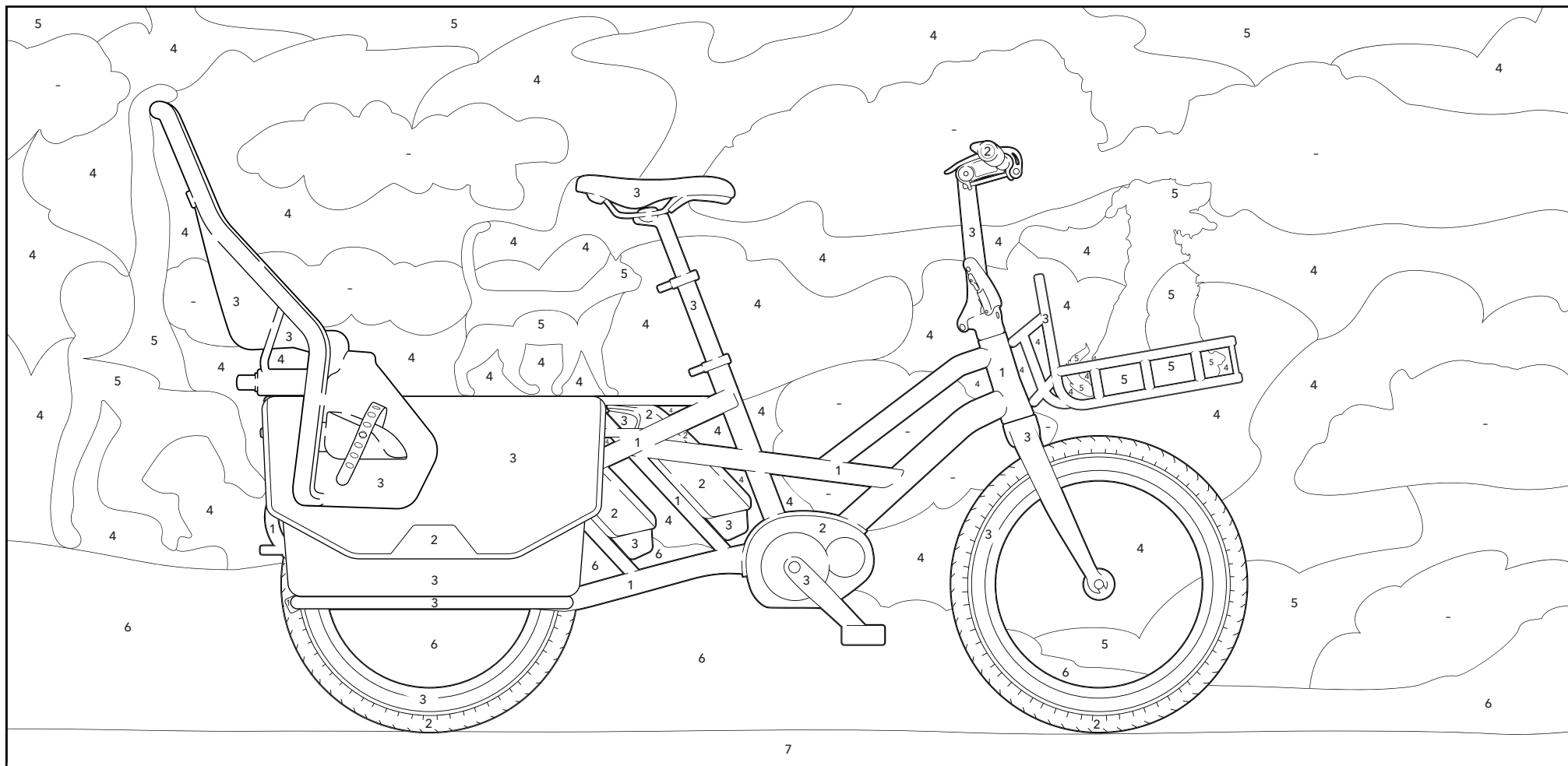

- | | | | |
|--|--|--|---|
| 1  Mango* | 3  Dark Gray | 5  Dark Blue | 7  Light Green |
| 2  Light Gray | 4  Light Blue | 6  Dark Green | -  (White) |

*or GSD Paint Color of your choice!



Connect the Dots

BEGINNER

Follow the numbers to reveal your cuddly passenger

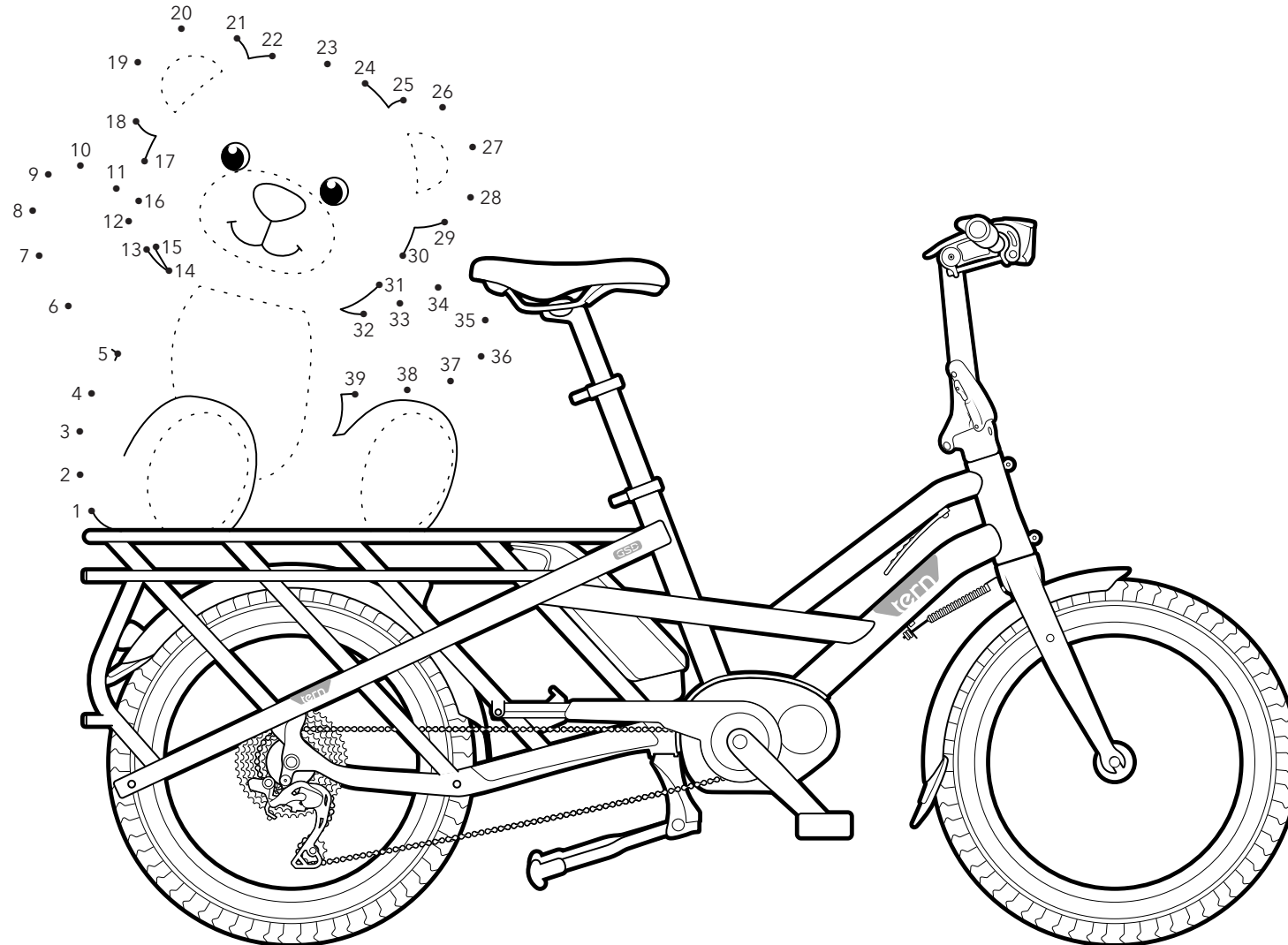

Complete the Drawing

BEGINNER

Can you draw the missing parts?

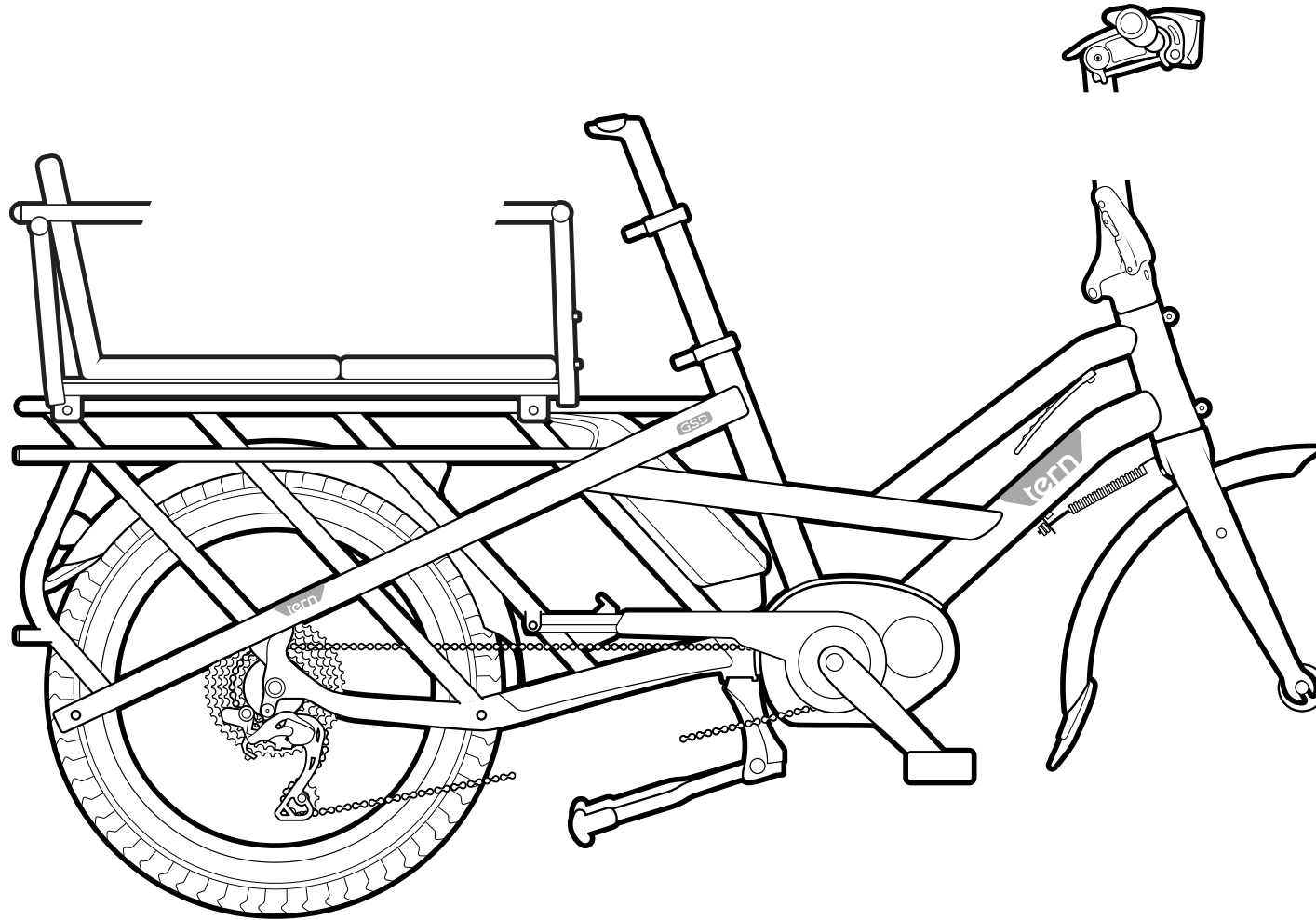

Solve the Maze

BEGINNER

Help bear find the paintbrush

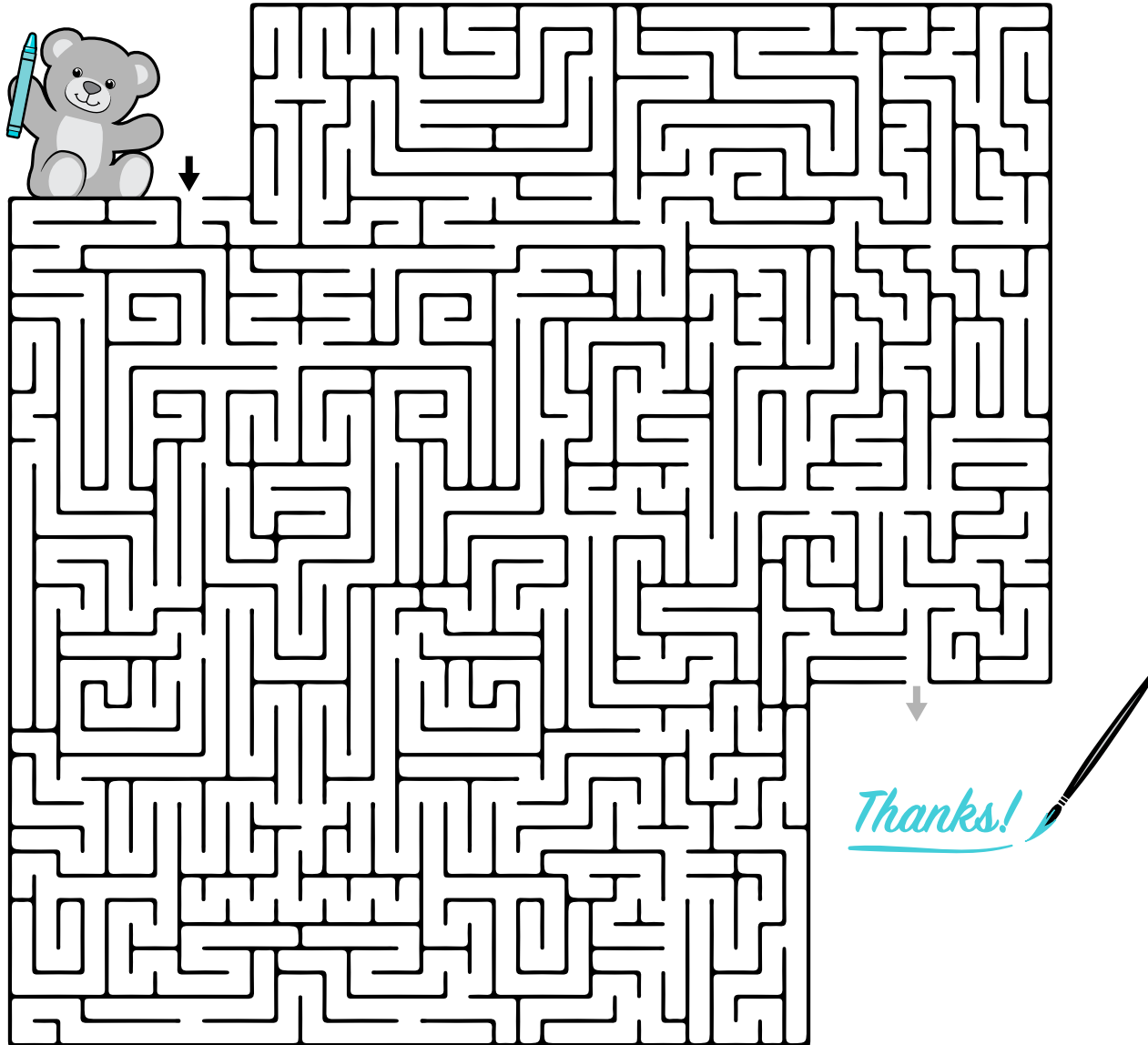

Solve the Maze

ADVANCED

Keep Calm and Carry On

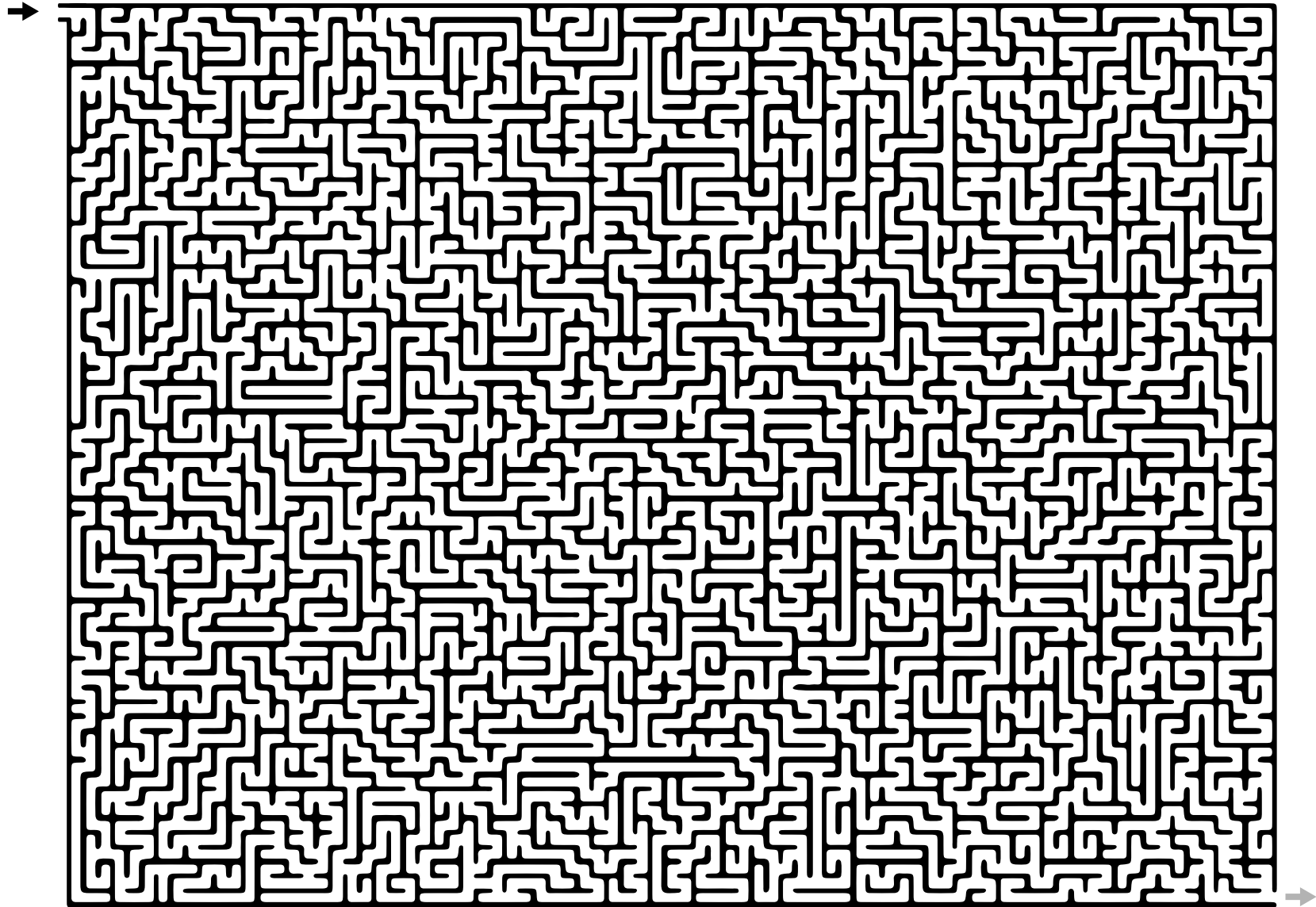

Connect the Dots

Earn a Badge of Achievement

ADVANCED

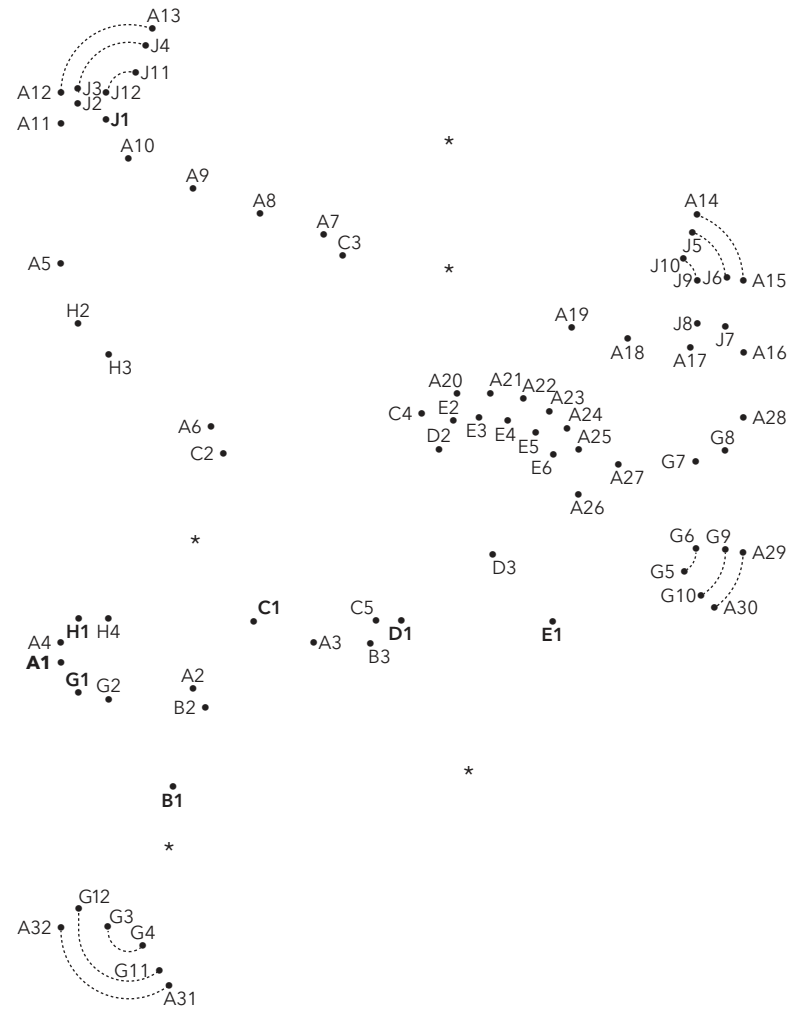

* Extra Credit: After connecting the dots, color in the shape marked with *



Complete the Drawing

ADVANCED

Can you draw the GSD frame?

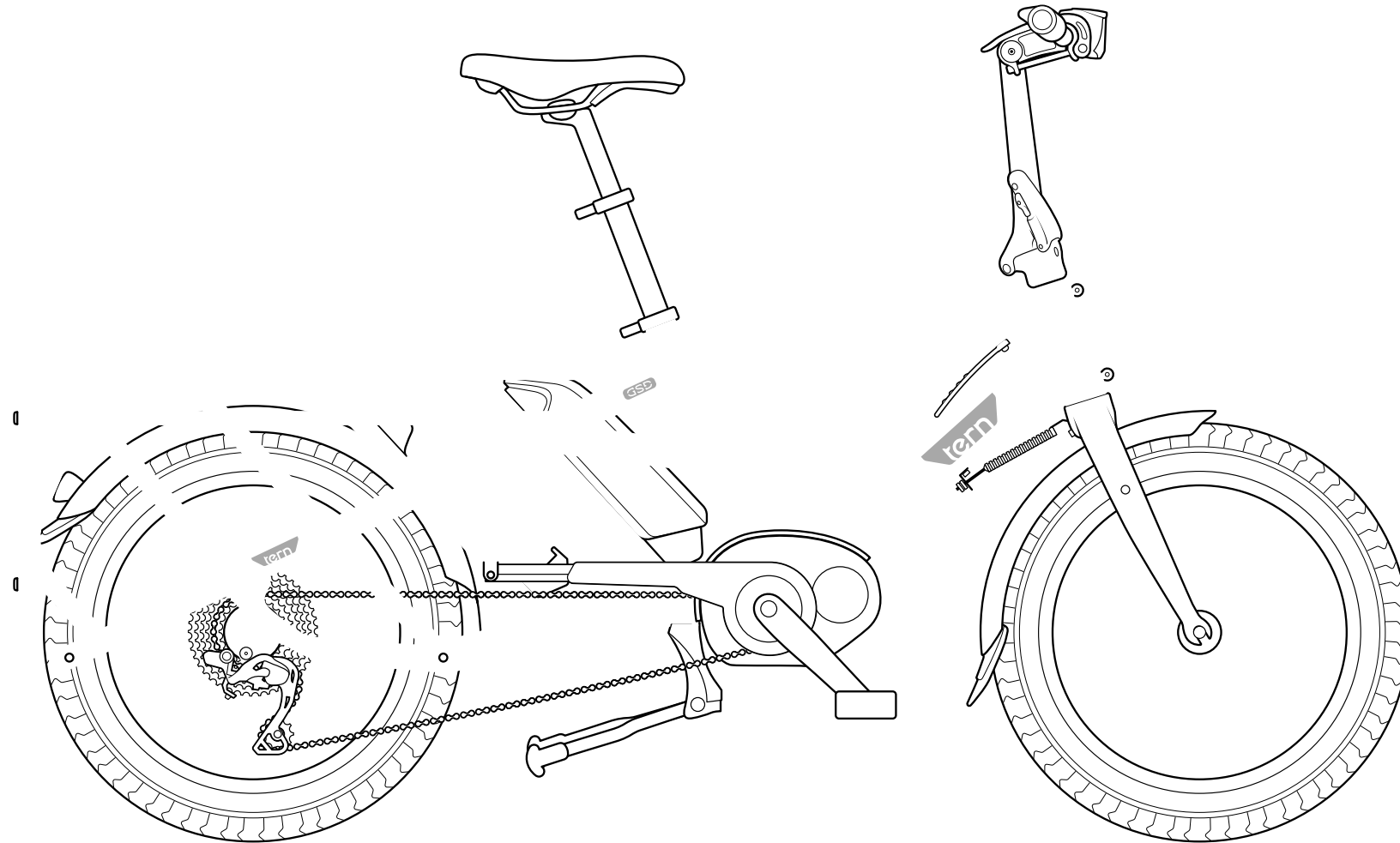

Coloring Meditation

ENLIGHTENED

Zen and the Art of Vertical Parking

